

REVISIONS				
ZONE	REV	DESCRIPTION	DATE	APPROVED

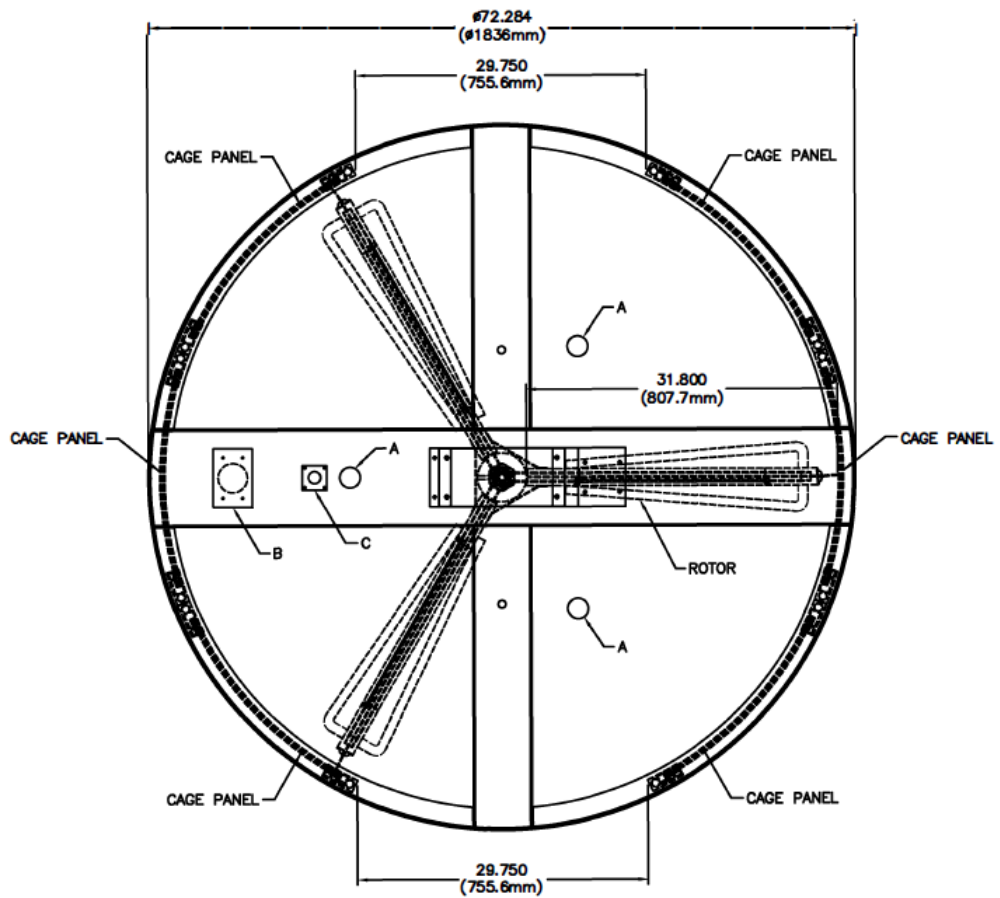
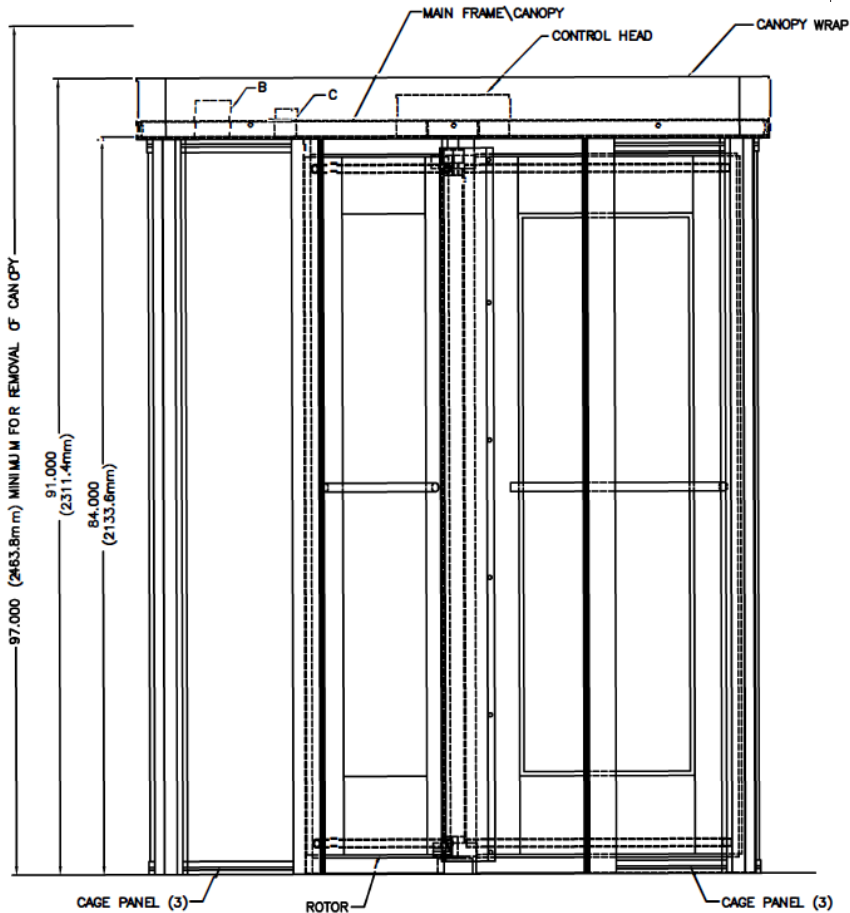

**Unless Otherwise Specified All Dimensions are in Inches**

**This drawing is to show dimensions of our products and should not be taken as a final visual representation. Drawings not to scale.**

This drawing is the property of Hayward Turnstiles Inc., and contains proprietary information, it may not be copied, reproduced or transmitted in any manner to a third party without prior written permission of Hayward Turnstiles Inc.

Material:

Finish:

# Hayward Turnstiles, Inc

## HT70 Full Height Turnstile Dimensions

SIZE	FSCM NO.	DWG NO.	HT70	REV
SCALE	None	SHEET		